

# ***Lift Rack Accessories***

***For Hunter wheel alignment lift racks***



# AlignLights

The AlignLights system provides a safe and efficient LED light source underneath the vehicle without additional electrical cords.

The lights automatically switch on when the lift is raised and off when the lift is lowered.

**20-3438-1 – for RX\_K models only**

**20-2993-1 – for L45x models**

*AlignLights is an ALI listed accessory for all lift models.*



*AlignLights is available for most Hunter alignment lifts as an installed option or can be retrofitted to most previously installed lifts.*

# Swing Air Jacks

Hunter Swing Air Jacks provide reliable, full-pneumatic operation.

Proven over decades of use, air-operated cylinders raise the vehicle from either the suspension or frame. Swing air jacks are engineered to handle a wide variety of vehicles and provide easy, low-maintenance service.



*Swing air jacks combine low drive-on height with high lifting capacity.*



**9,000-lb. Capacity,  
Triple Composite Cylinder Jack  
133-84-1**

Ideal for use with RX16, L45x lift models.



**6,000-lb. Capacity,  
Dual Composite Cylinder Jack  
133-85-1**

Ideal for use with RX-10 and RX12A lift models.

*Swing Air Jack clearances*

<b>A</b>	<b>Clearance</b>	1.5 in.
<b>B</b>	<b>Max. Low Flip</b>	16 in.
<b>C</b>	<b>Max. High Flip</b>	18 in.

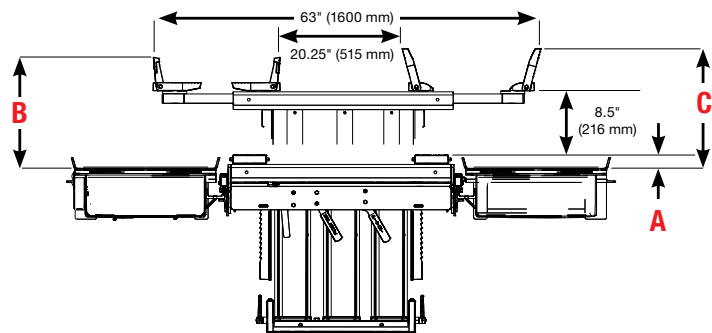

# Turnplates



## PowerSlide™ Turnplates

PowerSlide™ turnplates eliminate the hassle of removing and replacing lock pins during an alignment. Integrated bridges lower and raise as plates are locked. PowerSlide™ turnplates are an optional feature that may be added later to qualified RX and Four-Post series lifts.

<b>20-2076-1</b>	PowerSlide™ turnplates with automatic bridges	For use with camera-based alignment sensors
------------------	---	---



## Stainless Steel Turnplates

Resists corrosion and maintains free movement during the alignment procedure. Stainless steel construction for long, trouble-free life. No pointer.

<b>20-2532-1</b>	Stainless Steel (set of 2)	Fits 1.5" or 50 mm turnplate pockets <i>Includes guide strips</i>
<b>20-2533-1</b>	Stainless Steel, Low Friction (set of 2)	Fits 50 mm turnplate pockets <i>Includes guide strips</i>



## Painted Turnplates

### 20-2531-1BLK

Set of two turnplates for 1.5" or 50 mm turnplate pockets. Steel construction with a powder-coated paint finish. No pointer.



## Turnplate Bridge

Eases rolling compensation when rack is used with camera-based alignment sensors.

**20-2307-1** Universal Bridge for 50 mm and 1.5" turnplate pockets

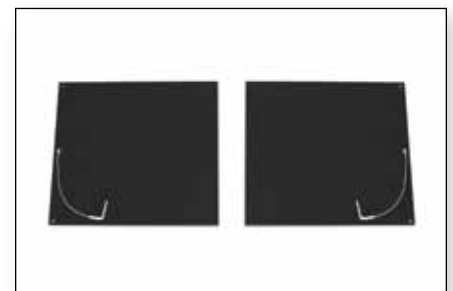

## Filler Plates

Fills turnplate pockets when turnplates are not used. 19.5" wide.

**20-2395-1BLK** For 50 mm pockets (two included)

# Ramps and Extensions

High-floor-slope conditions and low-ground-clearance vehicles occasionally require additional approach ramp length.

## Stage 2 RX Approach Ramp Extensions *(only available in red or black)*

<b>20-3113-1</b>	RX ramp extension kit (set of 2)	Adds 17.75" to the length of RX10K, RX9, RX10, and RX16 <i>Standard on RXDC, RX12K, and RX14K</i>
<b>20-2189-1</b>	RX ramp extension (incl. quick-release pins)	Adds 50" to length of RX10K, RX9, RX10, and RX16 Adds 37.25" to RX-12, RX12A, RX12K, and RX14K



## Stage 2 Four-Post Ramp Extension Kit *(only available in red or black)*

<b>20-3145-1</b>	Four-Post ramp extension for 26-in. runways	Adds 17.5" to length of ramps
<b>20-3146-1</b>	Four-Post ramp extension for 26-in. runways	Adds 40" to the length of ramps

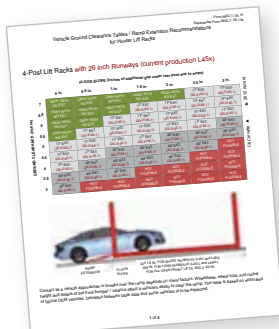

Refer to form **6652-T** for ramp extension recommendations based on vehicle ground clearance.

## Ramps and Extensions cont.

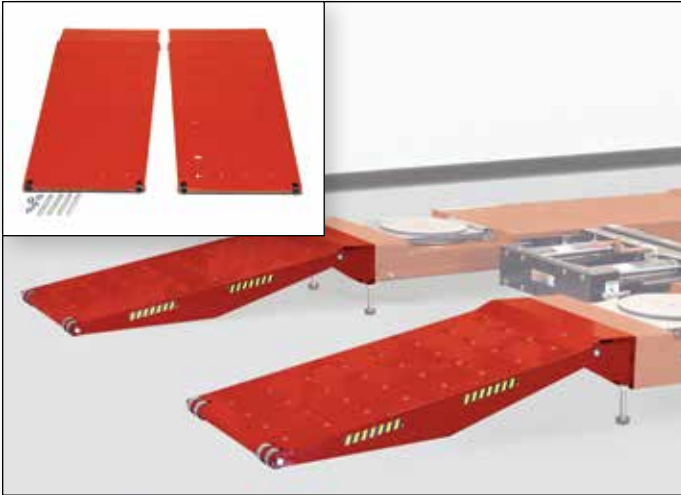

### Drive-Thru Kit – 20-2498-1

(Only available in red or black.)

RX10K, RX12K, and RX14K drive-thru kit for camera sensors

Also suitable for legacy RX10, RX12A, and RX16 racks

Adds 52" to overall length

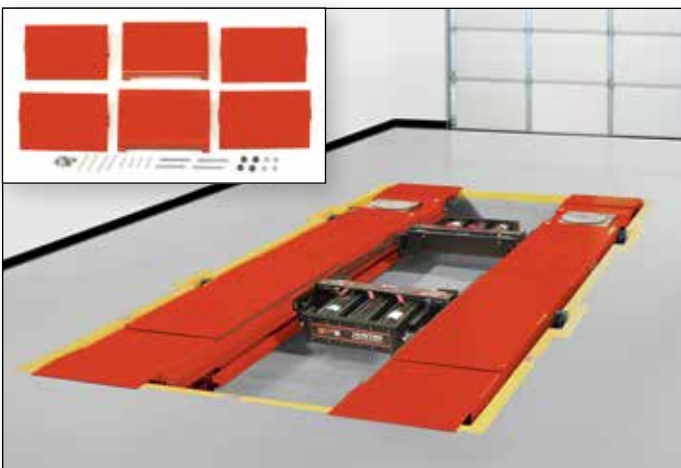

### Flush-Mount Conversion Kit – 20-2736-1

Converts surface-mount installations to flush-mount installations, using current site requirements. *(Only available in red or black.)*

For RX10K and RX12K

Also fits legacy RX10 and RX12A racks

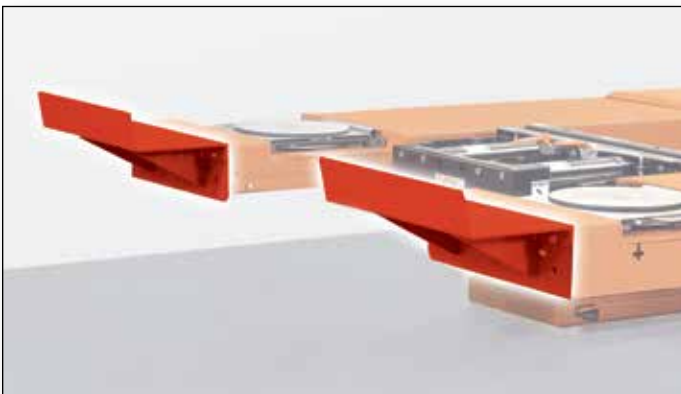

### Long Wheel Stops – 20-2497-1

For use with conventional sensors and vehicles with low spoilers. *(Only available in red or black.)*

Fits current RX10K, RX12K, RX14K racks, as well as legacy RX10, RX12A, and RX16 racks

Adds approximately 12" in length

# Additional lift accessories

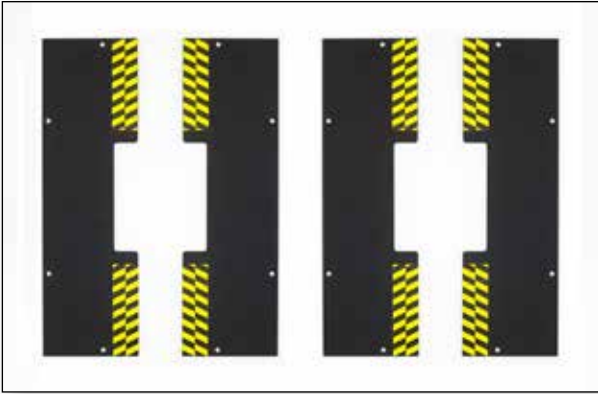

## Pit Hose Reel Cover Plates (set of 4) 20-2267-1

Cover plate for Inflation Station lifts to trim around flush-mount cut-outs.

**51-2308-1** Single pit hose reel cover plate



## Work Step – 51-1696-1

Work step makes custom steer or underhood shim work easier. Can be used with RX, L45X, L42X, L44X, RM, PN and RMHD models.

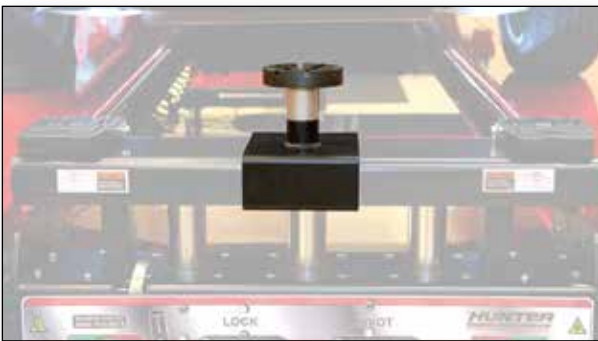

## Center Lift Jack Adaptor

**20-2854-1** (6,000 lb) **20-2853-1** (9,000 lb)

Ideal accessory for lifting from the differential or subframe on many vehicles. Includes storage bracket.

Suitable for **133-84-1** and **133-85-1** jacks only.

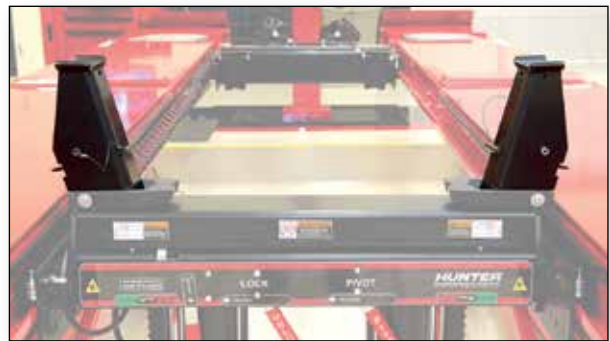

## Jack Riser Kit (set of 2) – 20-2801-1

Extends the reach of the jack to make lifting high- ground-clearance and long-wheelbase vehicles easier. Adds 4.5" to overall jack lift height.

Suitable for **133-84-1** and **133-85-1** jacks only.



## Front-Mount Power Unit Bracket – 20-3072-1

*For L45x models*

Moves power unit mounting to front of four-post column for bays with very little space.

# Additional lift accessories

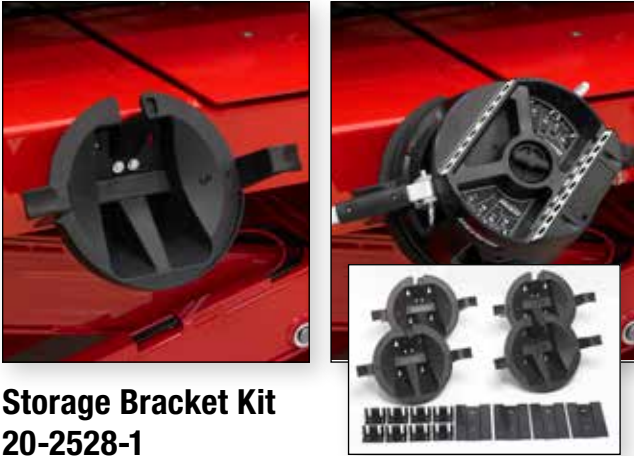

## Storage Bracket Kit 20-2528-1

Provides storage for wheel adaptors on console, lift or HawkEye Elite® sensor column. Simply bolts on to clip-on work step holes, no drilling required. Includes four brackets.



## Wheel Chock – 22-525-2

Prevents vehicle from rolling once on the lift. Two chocks are included standard in any new lift purchase.



*Be sure to check out Hunter's lift rack literature for more detailed information on each product.*

*Because of continuing technological advancements, specifications, models, and options are subject to change without notice.*

*WinAlign and HawkEye Elite are registered trademarks of Hunter Engineering Company.*

0823EH

Copyright © 2023, Hunter Engineering Company

**HUNTER**  
**Engineering Company**

[www.hunter.com](http://www.hunter.com)

Form RB05262-00, 08/23  
Supersedes Form RB05262-00, 07/23