

Inspection Ordering Guide

Choose the right inspection equipment for your market



Passenger



Medium-Duty



Heavy-Duty

Inspection Equipment Considerations

Alignment Sensors

PASSENGER	DRV1	Best for wheel assemblies up to approx. 32" in diameter
COMMERCIAL	HDRV1	Best for wheel assemblies greater than 30" in diameter





Tread Depth Sensors

PASSENGER	QTEF	Best for vehicles up to 7,000 lbs. per axle
COMMERCIAL	QTHD	Best for vehicles from 7,000 to 20,000 lbs. per axle

Console

PASSENGER	WU592	Pair with DRV1 and QTEF tread sensors
MEDIUM-DUTY	WU592MD	Pair with DRV1 and QTHD sensors
COMMERCIAL	WU592HD	Pair with HRDV1 and QTHD tread sensors

Make/Model Examples:

<p>LIGHT-DUTY CONFIGURATION</p>  <p>KIA RIO</p>	<p>MEDIUM-DUTY CONFIGURATION</p>  <p>RAM 3500 HD</p>	<p>HEAVY-DUTY CONFIGURATION</p>  <p>PETERBILT 350</p>
 <p>HYUNDAI PALISADE</p>	 <p>MACK GRANITE</p>	



Flightboard™ available with all systems (monitor not included)

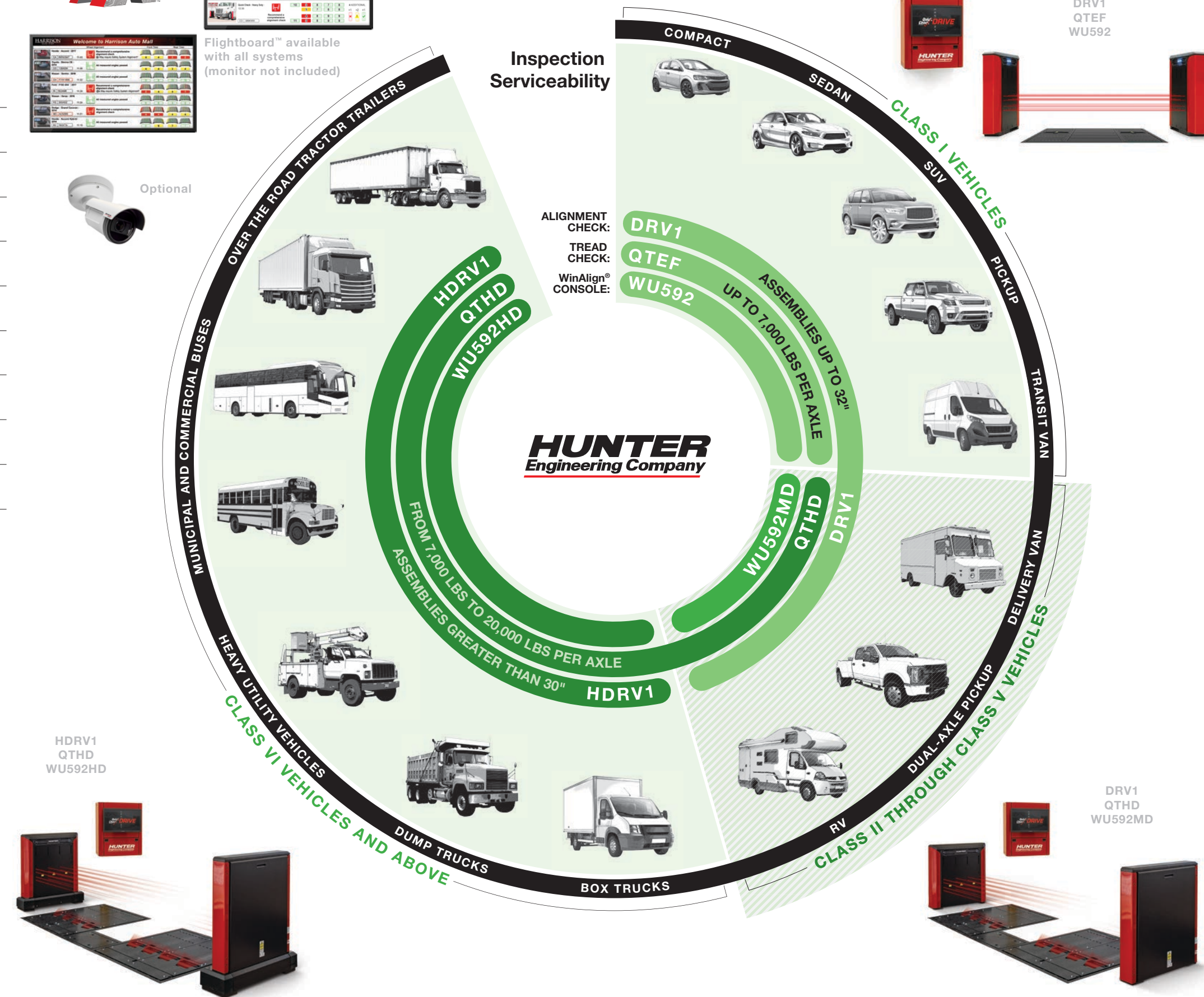

DRV1
QTEF
WU592

DRV1
QTHD
WU592MD

External Camera

Choose a long or short focal length to maximize readability and accuracy

- ✓ External camera solves difficult install situations such as low lighting, daylight glare, and field of view obstacles
- ✓ Flexible camera installation options include indoor or outdoor placement, ceiling- or wall-mounted, and center or off-center locations



Service Writer Configuration – Long Focal Length Recommended



20-3541-1

Long focal length camera for Quick Check Drive®
For plate-to-camera distance of greater than 180 in.
Used with systems installed in the middle of service drive

Lane Entrance Configuration – Short Focal Length Recommended



20-3584-1

Short focal length camera for Quick Check Drive®
For plate-to-camera distance of 96-180 in.
Best for systems installed near service drive entrance

Flightboard™

Display sourced locally.
Refer to 7614-T for more information.

Automatically display light-duty results display with Flightboard™ using HunterNet®

Light-Duty Flightboard™ — Results shown dependent on selected equipment. Passenger Inspection Systems only display up to four wheels per vehicle. For two-axle vehicles with more than four wheels, like dually pickups, an HD console is required.

HARRISON auto mall		Welcome to Harrison Auto Mall			
		Wheel Alignment	Front Tires		Rear Tires
	Honda : Accord : 2017 CA 6WNV647 11:43	Recommend a comprehensive alignment check ⊕ May require Safety System Alignment®	4	4	2 2
	Toyota : Sienna CE : 2014 CO 139XDH 11:36	All measured angles passed	4	4	3 4
	Nissan : Sentra : 2016 OH FYW1888 11:32	All measured angles passed	9	9	10 10
	Ford : F150 4X4 : 2017 IN 592ANR 11:29	Recommend a comprehensive alignment check ⊕ May require Safety System Alignment®	2	4	4 1
	Nissan : Versa : 2016 KS 355ADZ 11:24	All measured angles passed	8	8	9 9
	Dodge : Grand Caravan : 2014 MO AC6Z8S 11:21	Recommend a comprehensive alignment check	4	4	4 4
	Honda : Accord Hybrid : 2014 NV 740XTN 11:19	All measured angles passed	6	6	7 7









Medium- and Heavy-Duty Flightboard™ — Heavy-duty console required to display more than four wheels per vehicle. Results shown dependent on selected equipment.

BIG TONY'S TRUCK CENTERS		Welcome to Big Tony's Truck Service						
Vehicle	Wheel Alignment	Steer Tires	Drive Tires		Additional Tires			
AE-89002 Quick Check : Heavy Duty : 13:09 PA AE89002	Recommend a comprehensive alignment check	9	6	7	9	9		
103-658 Quick Check : Heavy Duty : 12:56 WV B103658	Recommend a comprehensive alignment check	5	6	6	7	10	10	
389-KNW Quick Check : Heavy Duty : 12:39 CO 389KNW	Recommend a comprehensive alignment check	10	3	8	7	8	4 ADDITIONAL +1 +2 +1	
		11	4	8	9	9		







Ordering

Passenger Alignment & Tread Depth Supergroup

<p>1 Sensors</p> <p>✓ QCD</p> <p>DRV1 Quick Check Drive® alignment sensors</p>  <p>Supergroups include: BDC Damage-Cam with standard 90-day storage*</p> 	+	<p>2 Console</p> <p>✓ 92</p> <p>WU592 wall-mounted Quick Check Drive® console</p> 	+	<p><i>RECOMMENDED</i></p> <p>3 Tire Tread</p> <p>✓ TF</p> <p>QTEF Quick Tread Edge® flush-mounted sensors</p> 	+	<p><i>RECOMMENDED</i></p> <p>4 Enhanced Vehicle ID</p> <p>✓ ECS</p> <p>20-3584-1 External vehicle identification camera** (short focal length)</p> 	+	<p>QCD92TFECS</p> 
------------------------------------------------------------------------------------------------------------------------------------------------------------------------------------------------------------------------------------------------------------------------------------------------------------------------------------------------------------	---	------------------------------------------------------------------------------------------------------------------------------------------------------------------------------------------	---	----------------------------------------------------------------------------------------------------------------------------------------------------------------------------------------------------------------------	---	-----------------------------------------------------------------------------------------------------------------------------------------------------------------------------------------------------------------------------------------------------------------	---	--------------------------------------------------------------------------------------------------------------

Stand-Alone Passenger Tread Depth

<p>1 Sensors</p> <p>✓ QTE</p> <p>QTE Quick Tread Edge® sensors</p> 	+	<p>2 Console</p> <p>✓ 92</p> <p>WU592 wall-mounted Quick Tread Edge® console</p> 	+	<p><i>RECOMMENDED</i></p> <p>3 Flush-Mounting</p> <p>□ F</p> <p>QTEF Quick Tread Edge® flush-mounted sensors</p> 	+	<p>4 Quick ID™</p> <p>✓ IDS</p> <p>QIDS Quick ID™ vehicle identification system (short focal length)</p> 	+	<p>QTE92IDS</p> 
-----------------------------------------------------------------------------------------------------------------------------------------------------------------------------	---	-------------------------------------------------------------------------------------------------------------------------------------------------------------------------------------------	---	---------------------------------------------------------------------------------------------------------------------------------------------------------------------------------------------------------------------------	---	-------------------------------------------------------------------------------------------------------------------------------------------------------------------------------------------------------------------------	---	--------------------------------------------------------------------------------------------------------------



Equipment also available in black (add **BLK** to part#)

Tread Depth ramps available only in black

* Requires active HunterNet® subscription (3-years included)

** Recommended in all locales for best performance on new/redesigned license plates. Refer to **7563-T** for more details

Medium-Duty Alignment & Tread Depth a-la-carte

1 Sensors



DRV1 Quick Check Drive® alignment sensors



Supergroups include:
BDC Damage-Cam with standard 90-day storage*



2 Console



WU592HD wall-mounted console



RECOMMENDED

3 Tire Tread



QTHD Quick Tread HD flush-mounted* sensors

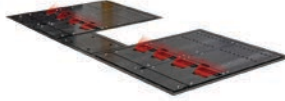

4 Enhanced Vehicle ID



20-3584-1 External vehicle identification camera**
(short focal length)



or 20-3541-1 for long focal length option



(one example)

Heavy-Duty Alignment & Tread Depth Supergroup

1 Sensors



HDRV1 Quick Check HD alignment sensors



2 Console



WU592HD wall-mounted console



RECOMMENDED

3 Tire Tread



QTHD Quick Tread HD flush-mounted* sensors



RECOMMENDED

4 Enhanced Vehicle ID



20-3584-1 External vehicle identification camera**
(short focal length)

IMPROVES BUMPER-TO-BUMPER TIME!



or 20-3541-1 for long focal length option



(one example)

Heavy-Duty Tread Depth a-la-carte

1 Tire Tread



QTHD Quick Tread HD flush-mounted* sensors

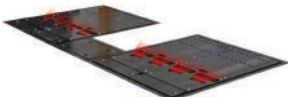

2 Quick ID™



QIDS External vehicle identification camera**
(short focal length)



or QID for long focal length option

3 Console



Wall-mounted console



Flush-Mount Pit Insert

Quick Pit Single Pour Frame and Tub – 20-3701-1

For vehicles with axle weight up to 7,000 lbs.

Complete QTEF pit construction in as few as eight hours and avoid lengthy service drive disruptions.*

Ordered separately.

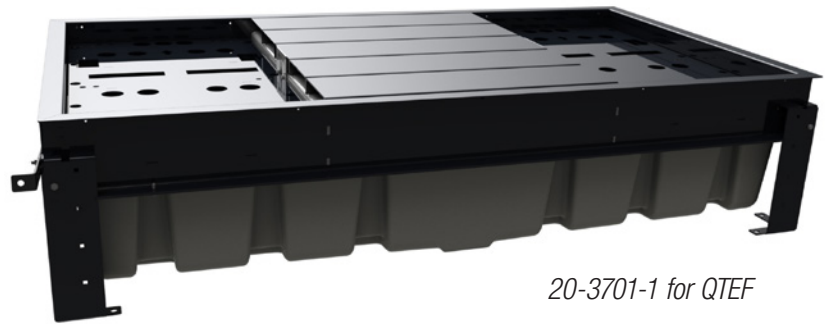

20-3701-1 for QTEF



Heavy-Duty Quick Pit Single Pour Frame and Tub – 20-3818-1

For vehicles with axle weight greater than 7,000 lbs.

Complete QTHD pit construction in as few as eight hours and avoid lengthy service drive disruptions.*

Ordered separately.

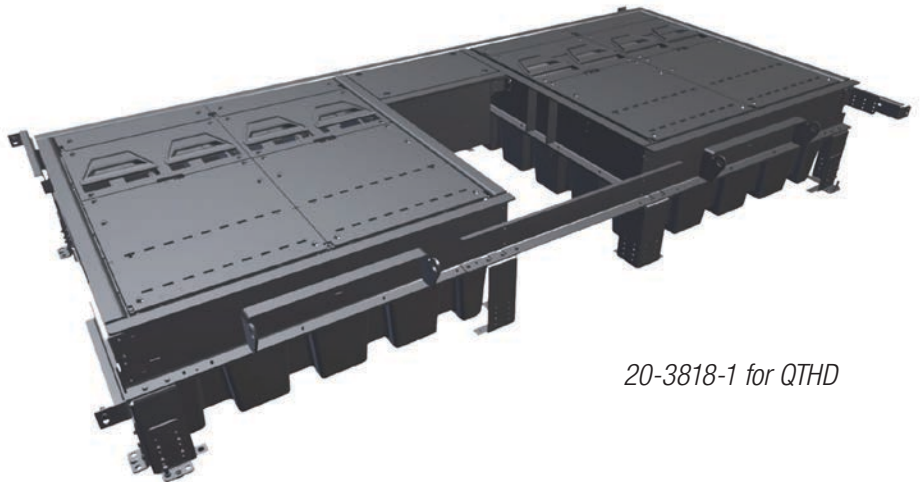

20-3818-1 for QTHD



**Total construction time requirements determined by local contractor.*

HUNTER
Engineering Company

www.hunter.com